

FLOS

F1856044 Anodized Champagne

Coordinates Ceiling 4

Designed by Michael Anastassiades, 2020



157W - 8830lm - 2700K - CRI > 95

Coordinates is a lighting system with diffuse light composed of horizontal and vertical luminaries arranged in a bright grid of various shapes and complexities. Each element is made of extruded anodized aluminium with a champagne finish and a diffuser in platinum optical silicone with an integrated LED strip (CRI 95). Each element is powered and supported by an invisible electrical and mechanical connection designed specifically to allow for the composition of the 3 ceiling models (C1 – C2 – C4), which may be combined with the respective Long versions for the highest ceilings (C1 Long, C2 Long, C4 Long). The 'C Module' is also available. Its geometry was designed to be repeated to create large grids for custom installations. Each Coordinates configuration includes its own ceiling rose, whose integrated electronics allow for the use of different dimmer systems: push, 1-10, DALI. In the absence of these systems, the amount of light can be set during installation with the push system included in the rose. The related CI III version is also available for each configuration for installations with a remote power supply.

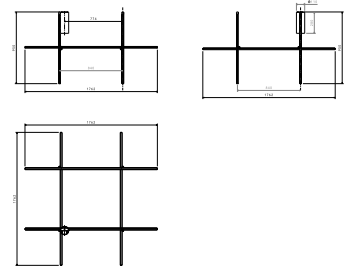

Are you a professional and your project needs consulting and support?

[BOOK AN APPOINTMENT](#)

Main specifications

EAN	8059607001684
Mounting	Ceiling
Environments	Indoor dry location
Light Source Type	LED
LED type	LED Module
Power (W)	157
System flux (lm)	8830

Physical

Colour	Anodized Champagne
Length (mm)	1770
Net weight (kg)	8.1
Package height (mm)	0
Package width (mm)	0
Package length (mm)	0
Package volume (m3)	0.07
IP internal	20

Download

Mounting instructions [↓ PDF](#)

Photometric Files

ULD [↓ ZIP](#)

Technical Drawings

3D [↓ ZIP](#)

[🔒 Bim](#) [↓ ZIP](#)



Photometric

Lighting type	Total
Light distribution	Asymmetric
CCT (K)	2700
CRI>	95

Electrical

Insulation class	I
Frequency (Hz)	50/60
Main voltage (Vac)	100-240
Driver	Integrated
Dimmable	Yes
Dimming type	Dimmable 0-10V, Dimmable Push, Dimmable 1-10V, Dimmable DALI 1
Dimming interface	Remote Dimmable (Dimmer Not Included)
Batteries inside	No

Ecodesign and Energy Labelling

This product contains a light source of energy efficiency class F

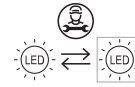

Replaceable (LED only) light source by a professional

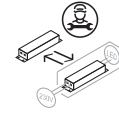

Replaceable control gear by a professional

Spare Parts

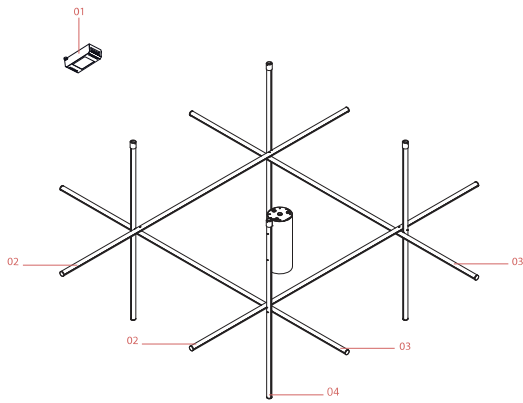

- | | | |
|-----|---|---------|
| 10. | Rod Assembly L1760 H-11
Anodized Champagne | RF30985 |
| 20. | Rod Assembly L920 CA-07
Anodized Champagne | RF30991 |
| 30. | Rod Assembly L920 C-09
Anodized Champagne | RF30993 |

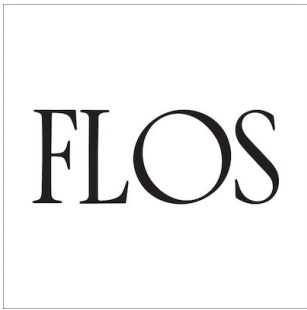

RF30985

Rod Assembly L1760 H-11
Anodized Champagne

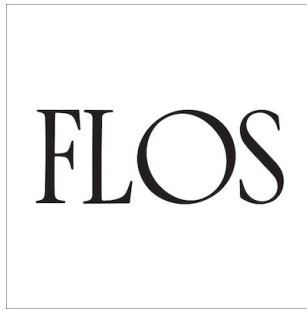

RF30991

Rod Assembly L920 CA-07
Anodized Champagne

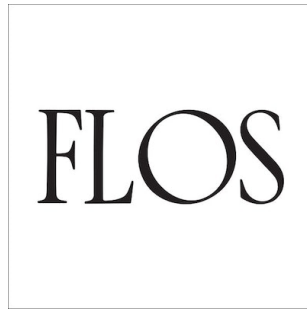

RF30993

Rod Assembly L920 C-09
Anodized Champagne