

Smart 48 + IP GE

128620XX_128720XX_128820XX

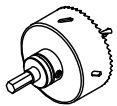
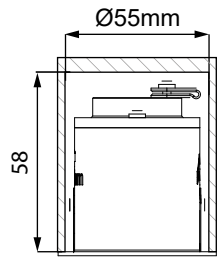
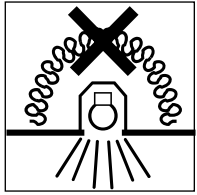

Ø44mm
(gips/gypsum/gypse/gips/gesso/rino)

Ø46mm
(hout/wood/bois/Holz/madera/legno/древесины)

Drive Current (mA)	Forward Voltage		Power (W)
	min (Vf)	max (Vf)	
350	7,5	9,5	3,0
500	7,5	9,5	4,3

For serial connection, respect polarity!

⊕ RED	⊖ BLACK
-------	---------

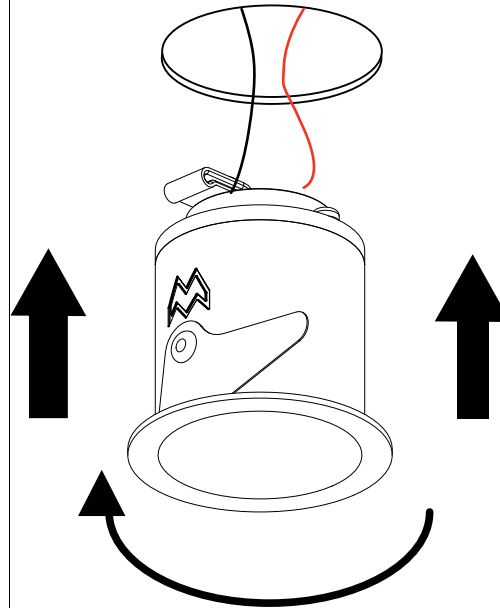
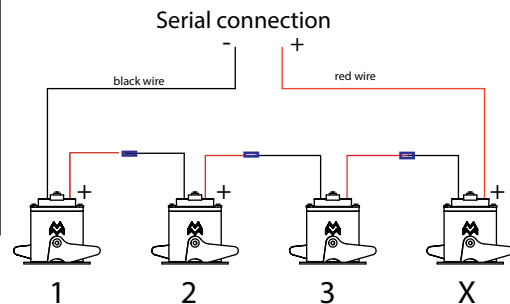
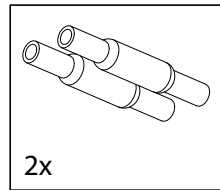
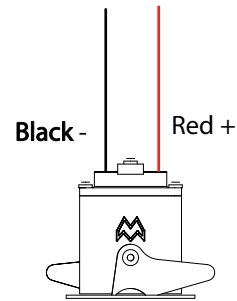

Twist counterclockwise to put through hole then twist clockwise to fixate

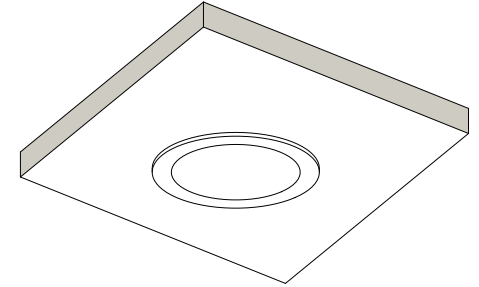

	Replace protective shield when broken. The luminaire shall only be used complete with its protective shield. Reference number: 1006610
--	---

	LIGHT SOURCE - DO NOT TOUCH LED Touching the LED can result in permanent damage of the light source. The light source contained in this luminaire shall only be replaced by the manufacturer or his service agent or a similar qualified person.
--	--

	PREVENTING ELECTROSTATIC DAMAGE A discharge of static electricity may damage sensitive components. Always be properly grounded when touching leads or circuitry inside the luminaire. Use a wrist strap connected by a ground cord to the housing. Avoid touching the light sources with bare hands.
--	--

DRIVERS & ACCESSORIES
For latest version of driver matrix and available accessories check www.supermodular.com or connect with your sales contact.

