

HEXO

21-09-2015

1.0 LED

LED 8W | 220-240VAC | 50-60Hz | COB 2-step | incl. PS | phase-cut dim

CE IP20 960°C 0,3m 36° P

white texture	146564W
gold	146564G
bronze	146564Q
copper	146564P
black texture	146564B

LIGHT COLOUR

2200K >80CRI 315lm	1
2700K >80CRI 480lm	2
3000K >80CRI 480lm	4

1.0 PAR16

PAR16 max. 35W | GU10 | 220-240VAC | 50-60Hz

CE IP20 960°C 0,9m

white texture	146520W0
gold	146520G0
bronze	146520Q0
copper	146520P0
black texture	146520B0

OPTIONAL

for PAR16 lamps see our catalogue

OPTIONAL

inner cover max. 10W

white texture	911031W1
gold	911031G1
black texture	911031B1

base plate dimensions

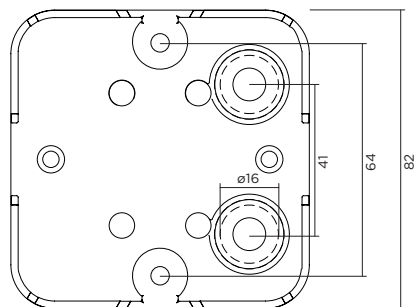

1.0 LED

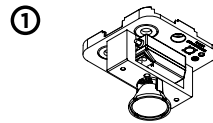

1.0 PAR16

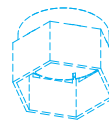
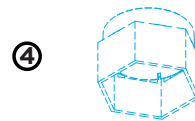
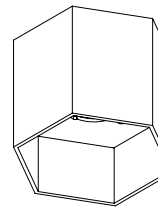
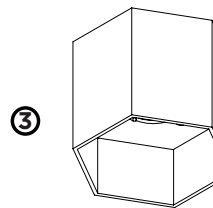
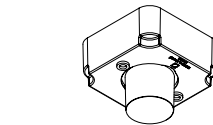
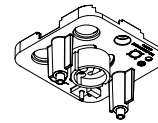

DIMENSIONS

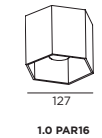
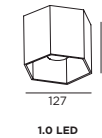

1 MOUNTING INSTRUCTION

Remove the screws for the top part, put the cables through the opening and mount the base on the ceiling.

2 POWER CONNECTION

Connect wiring to the power supply (for LED) or to terminal block (for PAR16)

interior connection: STANDARD version

exterior connection: WATERPROOF version (only for LED)

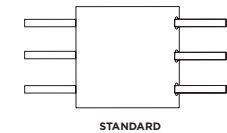

3 For LED:
fix the plastic part together with the cover on the base with the screws.

For PAR16:
fix the cover on the base with the screws.

4 OPTIONAL inner cover:
put the inner cover in the outer cover and turn partially.
In case of PAR16 with inner cover: max. 10W



WEVER & DUCRÉ
LIGHTING

www.weverducre.com

INSTALLATION
INSTRUCTIONS