

# I Lucci Argentati, school of *light*.

design Dodo Arslan  
terzani.com

**TERZANI**  
LA LUCE PENSATA



**Product Name**  
I Lucci Argentati  
small linear chandelier

**Materials**  
metal



### Finishes | Code

-  white  
ON82S M2 C8. L
-  brushed nickel  
ON82S H4 C8. L
-  brushed gold  
ON82S L9 C8. L

### Body

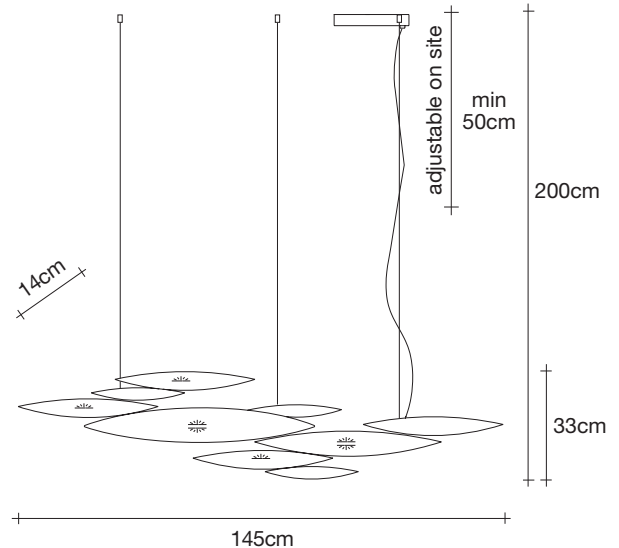

### Integrated Led

100-240V ~ 50/60Hz

 LED integrated  
7 x 4,5W 3710 lm CRI 90  
3000K or optional 2700K

### dimmable with

-  0/1-10V  
PWM  
10K-100K Ω  
PUSH  
DALI system

### Canopy

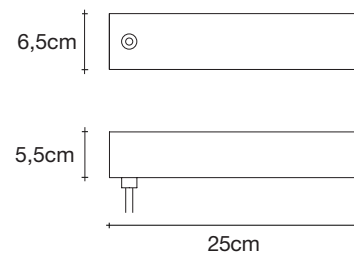

### Canopy for DALI

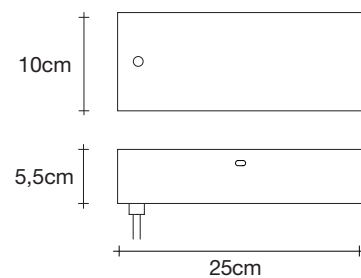

I Lucci Argentati draws from nature to create a whimsical, yet modern light. Recalling a school of fish darting through freshwater, it creates a mesmerizing luminescence. Sets of sleek lights combine to form a stunning pendant with thin incisions along the bottom creating an understated, tranquil beauty. Thanks to its modular system, I Lucci Argentati is customizable and can be combined in many different configurations: from small to extra large; as a pendant or sconce; and finished either in brushed nickel or white. Design Dodo Arslan.

# I Lucci Argentati, school of *light*.

design Dodo Arslan  
terzani.com



**Product Name**  
I Lucci Argentati  
medium linear chandelier

**Materials**  
metal



**Finishes | Code**

-  white  
ON83S M2 C8. L
-  brushed nickel  
ON83S H4 C8. L
-  brushed gold  
ON83S L9 C8. L

**Body**

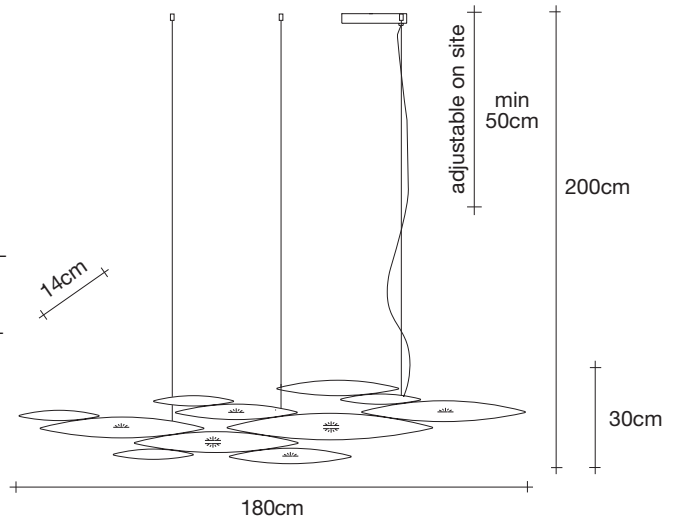

**Integrated Led**

100-240V ~ 50/60Hz

 LED integrated  
8 x 4,5W 4240 lm CRI 90  
3000K or optional 2700K

**dimmable with**

-  1-10V  
PWM  
10K-100K Ω  
PUSH  
DALI system

**Canopy**

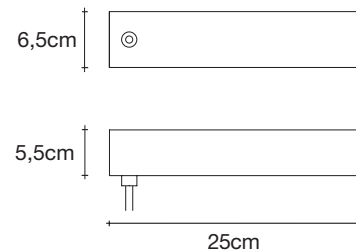

**Canopy for DALI**

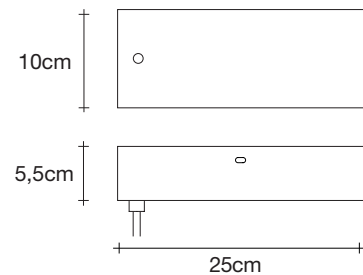

I Lucci Argentati draws from nature to create a whimsical, yet modern light. Recalling a school of fish darting through freshwater, it creates a mesmerizing luminescence. Sets of sleek lights combine to form a stunning pendant with thin incisions along the bottom creating an understated, tranquil beauty. Thanks to its modular system, I Lucci Argentati is customizable and can be combined in many different configurations: from small to extra large; as a pendant or sconce; and finished either in brushed nickel or white. Design Dodo Arslan.

# I Lucci Argentati, school of *light*.

design Dodo Arslan  
terzani.com

**TERZANI**  
LA LUCE PENSATA





**Product Name**  
I Lucci Argentati  
large linear chandelier

**Materials**  
metal



**Finishes | Code**

-  white  
ON81S M2 C8. L
-  brushed nickel  
ON81S H4 C8. L
-  brushed gold  
ON81S L9 C8. L

**Body**

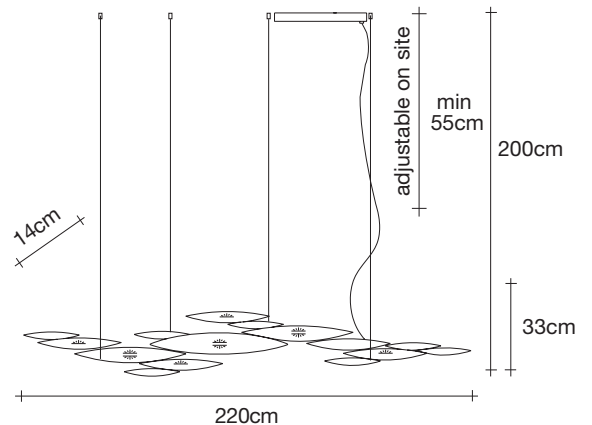

**Integrated Led**

230-240V ~ 50/60Hz

 LED integrated  
10 x 4,5W 5300 lm CRI 90  
3000K or optional 2700K

**dimnable with**

 0-10V  
PUSH  
DALI system

**Canopy**

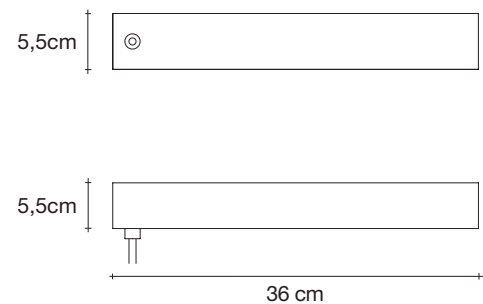

**Canopy for DALI**

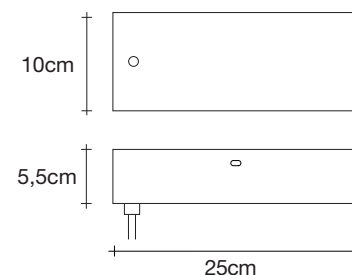

I Lucci Argentati draws from nature to create a whimsical, yet modern light. Recalling a school of fish darting through freshwater, it creates a mesmerizing luminescence. Sets of sleek lights combine to form a stunning pendant with thin incisions along the bottom creating an understated, tranquil beauty. Thanks to its modular system, I Lucci Argentati is customizable and can be combined in many different configurations: from small to extra large; as a pendant or sconce; and finished either in brushed nickel or white. Design Dodo Arslan.

# I Lucci Argentati, school of *light*.

design Dodo Arslan  
terzani.com



**Product Name**  
I Lucci Argentati  
xlarge linear chandelier

**Materials**  
metal



**Finishes | Code**

-  white  
ON80S M2 C8. L
-  brushed nickel  
ON80S H4 C8. L
-  brushed gold  
ON80S L9 C8. L

**Body**

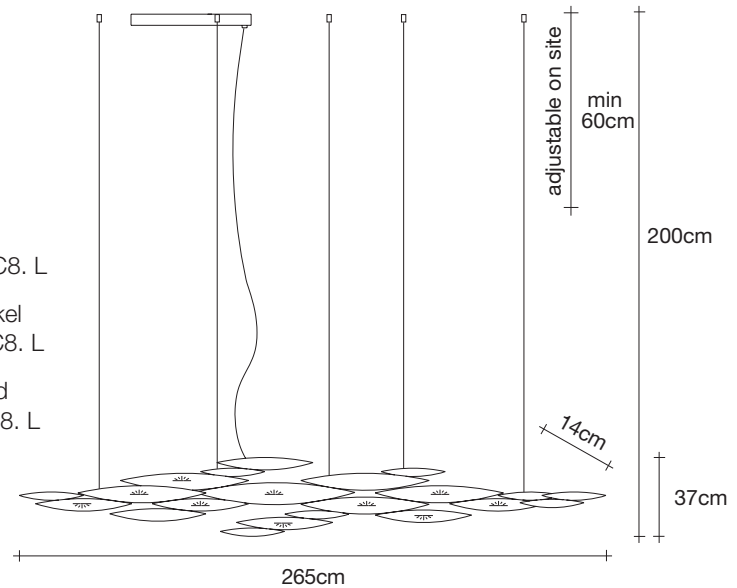

**Integrated Led**  
230-240V ~ 50/60Hz

 LED integrated  
10 x 4,5W 5300 lm CRI 90  
3000K or optional 2700K

**dimnable with**

 0-10V  
PUSH  
DALI system

**Canopy**

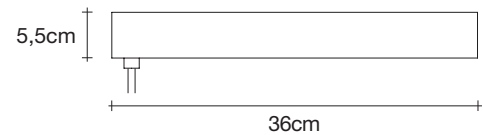

**Canopy for DALI**

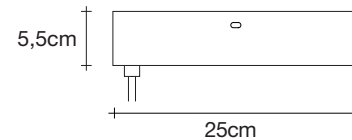
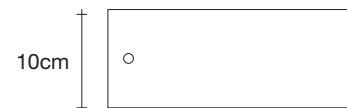

I Lucci Argentati draws from nature to create a whimsical, yet modern light. Recalling a school of fish darting through freshwater, it creates a mesmerizing luminescence. Sets of sleek lights combine to form a stunning pendant with thin incisions along the bottom creating an understated, tranquil beauty. Thanks to its modular system, I Lucci Argentati is customizable and can be combined in many different configurations: from small to extra large; as a pendant or sconce; and finished either in brushed nickel or white. Design Dodo Arslan.

# I Lucci Argentati, school of *light*.

design Dodo Arslan  
terzani.com



## Product Name

I Lucci Argentati  
wall sconce

## Materials

metal



## Finishes | Code

-  white  
ON85A M2 C8. LB
-  brushed nickel  
ON85A H4 C8. LB
-  brushed gold  
ON85S L9 C8. L

## Body

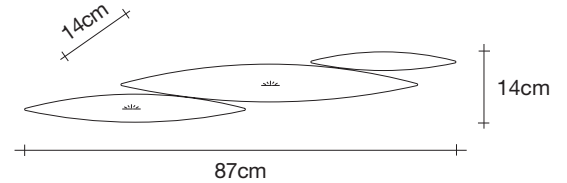

## Integrated Led

100-240V ~ 50/60Hz

 LED integrated  
2 x 4,5W 1060 lm CRI 90  
3000K or optional 2700K

 **dimmable with**

 0/1-10V  
PUSH  
DALI system

## Canopy

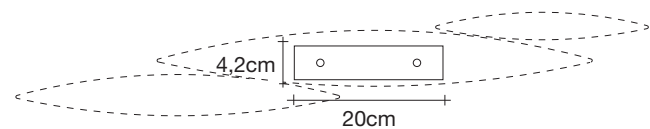

## Canopy for DALI

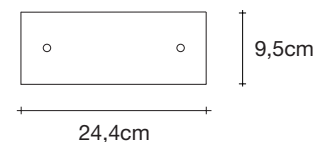

I Lucci Argentati draws from nature to create a whimsical, yet modern light. Recalling a school of fish darting through freshwater, it creates a mesmerizing luminescence. Sets of sleek lights combine to form a stunning pendant with thin incisions along the bottom creating an understated, tranquil beauty. Thanks to its modular system, I Lucci Argentati is customizable and can be combined in many different configurations: from small to extra large; as a pendant or sconce; and finished either in brushed nickel or white. Design Dodo Arslan.