

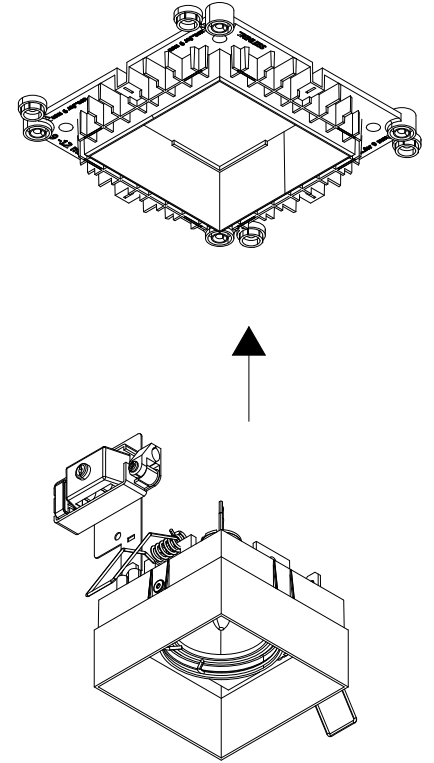

**MOUNTING KIT 75 TRIMLESS**  
202 01 75





**REF 202 51 51**

**WAARSCHUWING**  
**AVERTISSEMENT**  
**WARNUNG**  
**WARNING**  
**AMMONIZIONE**  
**EDVERTENCIA**

Lees de algemene gebruiksvoorwaarden: DEEL B  
Lire attentivement les conditions générales d'utilisation: PARTIE B  
Lesen Sie die allgemeinen Gebrauchsanweisungen: TEIL B  
Read the general directions: PART B  
Leggere attentamente le condizioni generali di utilizzazione: PARTE B  
Leer atentamente las condiciones generales de uso: PARTE B

 Bevestiging plafond inbouw  
Montage plafond encastré  
Montage decke eingebaut  
Fixation ceiling recessed  
Montaje techo empotrado  
Montaggio soffitto incasso

 Bevestiging wand inbouw  
Montage mur encastré  
Montage wand eingebaut  
Fixation wall recessed  
Montaje pared empotrado  
Montaggio parete incasso

 Installeer het armatuur enkel in ruimten waar direct contact met water onmogelijk is.  
Cet équipement doit être installé dans des pièces hors de toute projection d'eau.  
Diese Leuchte darf nur in Räumen verwendet werden, in denen ein direkter kontakt mit wasser nicht möglich ist  
This fitting should only be installed in rooms where direct contact with water is impossible  
Este aparato solamente puede ser instalado en habitaciones donde el contacto directo con el agua sea imposible  
Questo apparecchio di illuminazione deve essere installato solamente in locali in cui il contatto con l'acqua è impossibile.

# MOUNTING KIT 75 TRIMLESS

## INSTALLATION INSTRUCTIONS - PART A

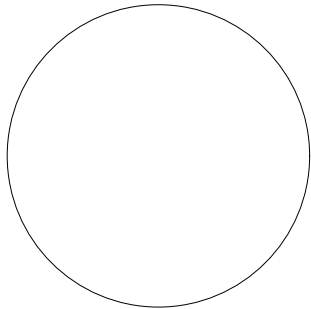
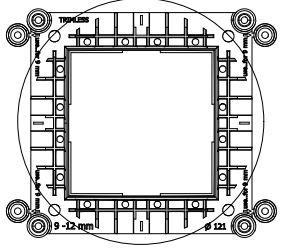

MOUNTING KIT 75 TRIMLESS

202 01 75

Ø = 121 mm

Ø121

01. TAKE PATTERN OUT OF BAG
02. MARK CENTERPOINT AND SCREWHOLE
03. DRILL HOLES
04. CUT INSTALLATION OPENING
05. PLACE KIT
06. FIX WITH SCREWS
07. FINISH WITH PLASTER
08. PAINT
09. INSTALL THE DEVICE

01

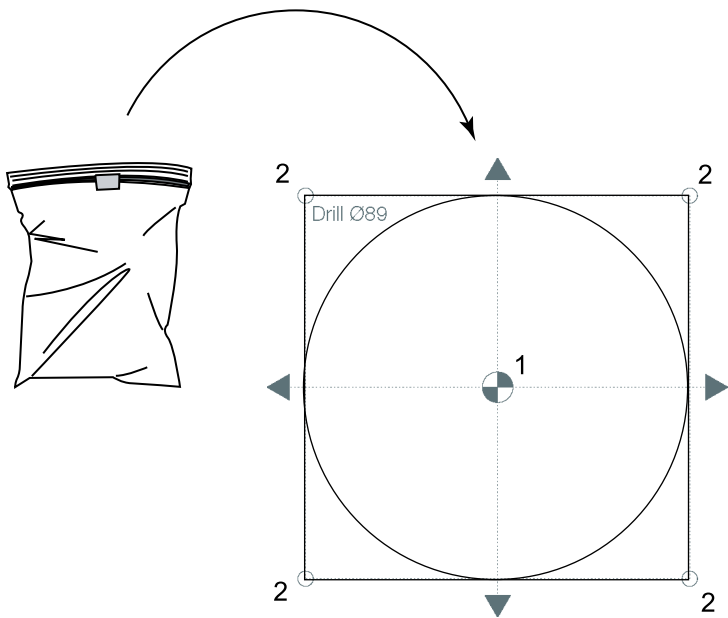

02

- MARK THE CENTERPOINTS
1. FOR INSTALLATION OPENING Ø 121
  2. FOR FIXATION SCREWS (4x)

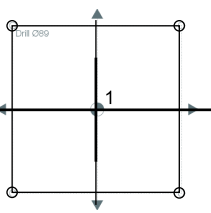
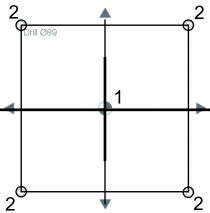

USE PATTERN TO ALIGN CENTERPOINTS

OR

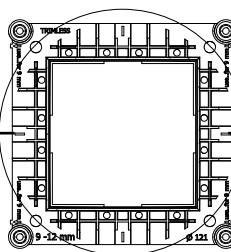
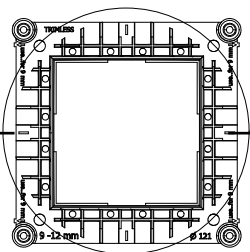

03

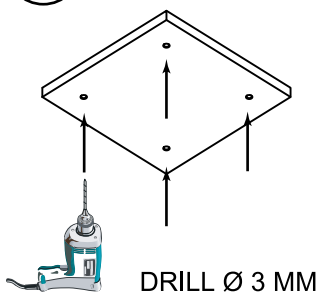

DRILL Ø 3 MM

04

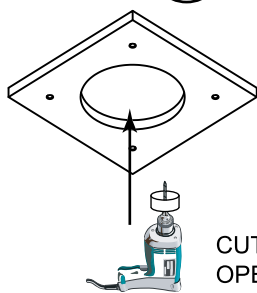

CUT INSTALLATION OPENING Ø 121 MM

05

9 MM

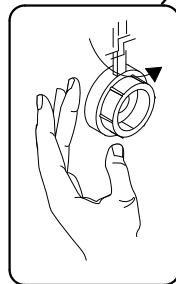
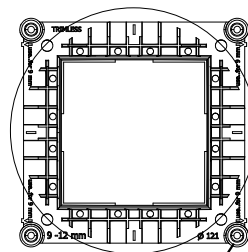
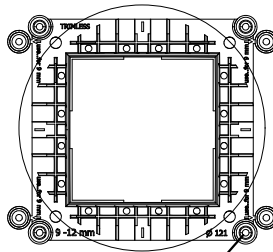

'CLICK' x4

12 MM

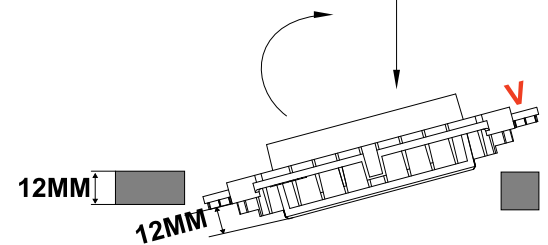
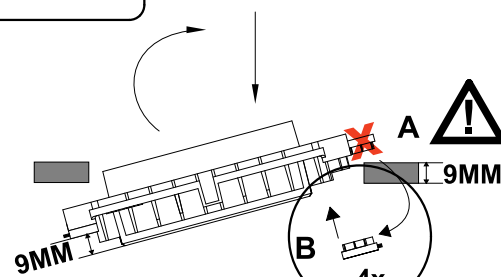
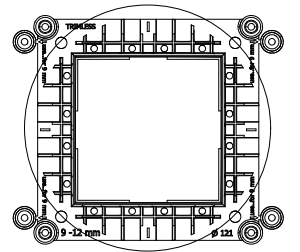

07 FILL WITH PLASTER

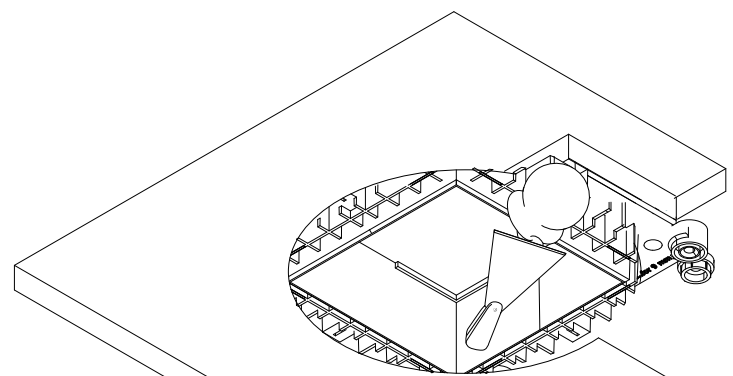

06 FIX IN PLACE WITH 4 SCREWS

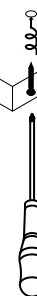

08 PAINT

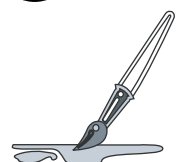

09 INSTALL THE DEVICE

