

	Ref.					
FIND ME 1	09.3750.dd	3000K	CRI90	6W	500mA	600 lm
	09.3751.dd	2700K	CRI90	6W	500mA	560 lm
	Ref.					
FIND ME Ø	09.3781.dd	2700K	CRI90	3W	250mA	300 lm
	09.3780.dd	3000K	CRI90	3W	250mA	325 lm

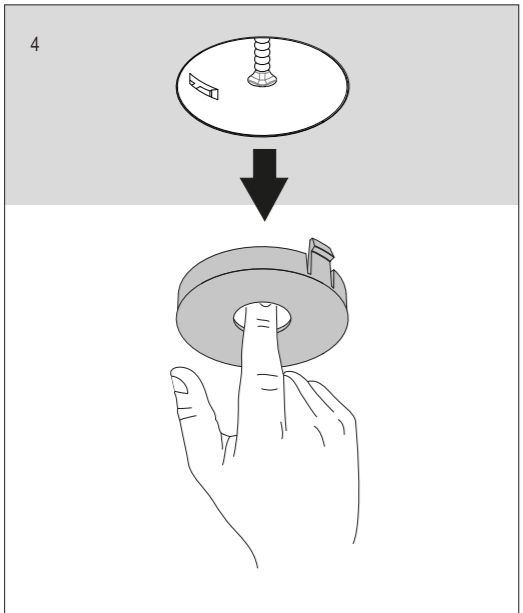

TRIM installation

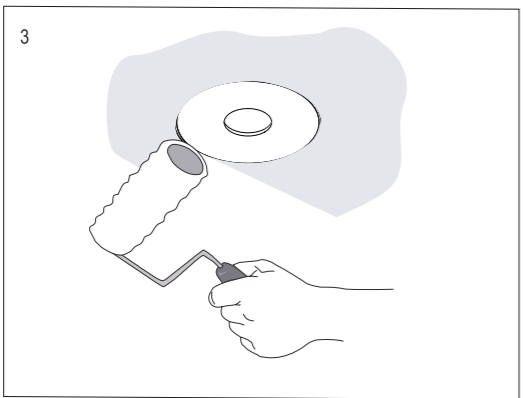
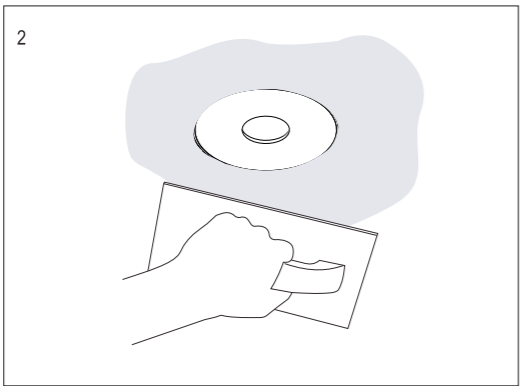
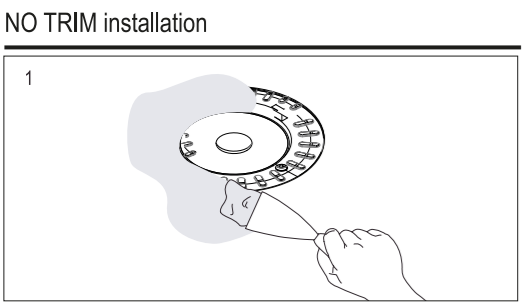
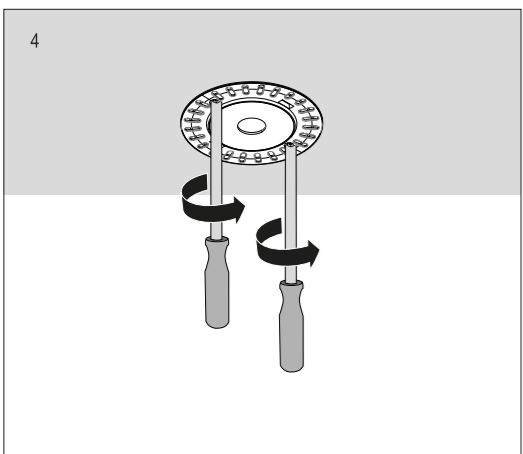
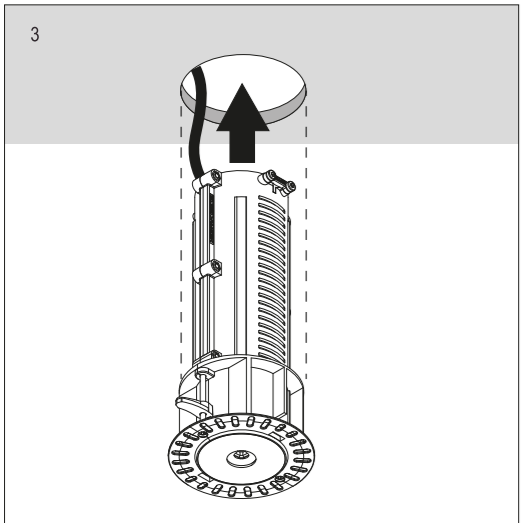
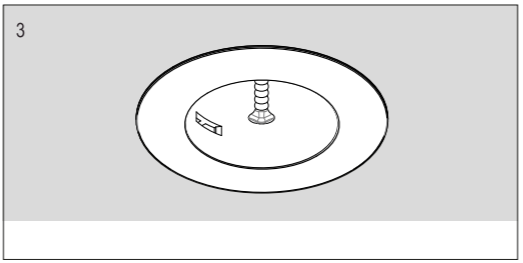
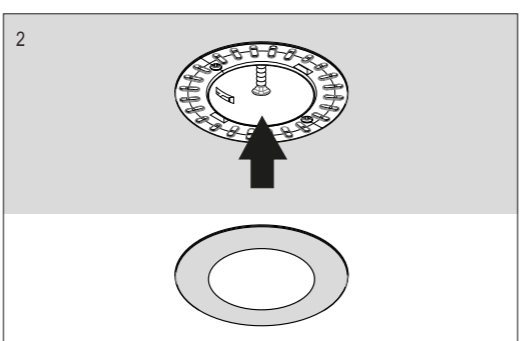
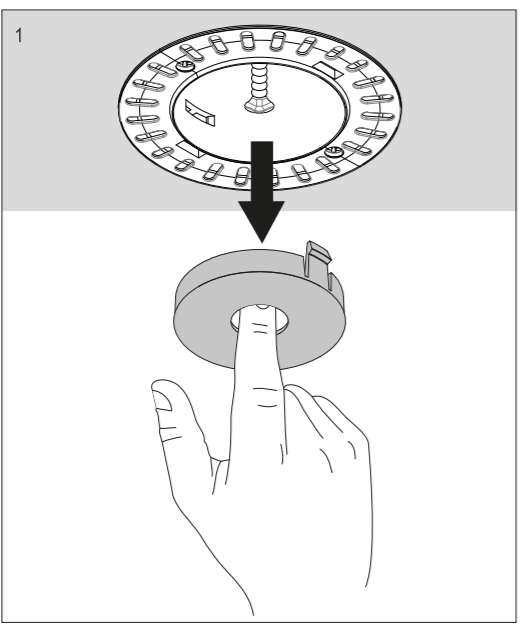

C ELECTRICAL CONNECTION

CONEXIÓN ELÉCTRICA / CONNESSIONE ELETTRICA / ELEKTRISCHER ANSCHLUSS / CONNEXION ÉLECTRIQUE / LIGAÇÃO ELÉCTRICA / のコネクション / 電力连接 / ЭЛЕКТРИЧЕСКОЕ ПОДКЛЮЧЕНИЕ / ЭЛЕКТРЛІК БАЙЛАНЫС / التوصيل الكهربائي

FIND ME 1 ref. 09.3750 / 09.3751

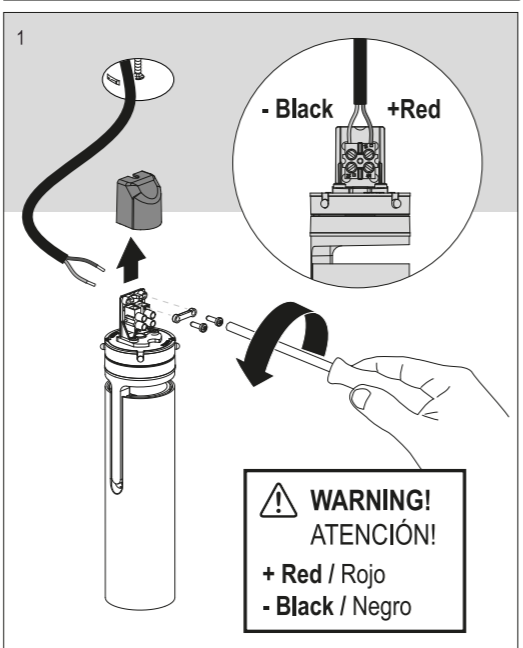

WARNING! ATENCIÓN!
+ Red / Rojo
- Black / Negro

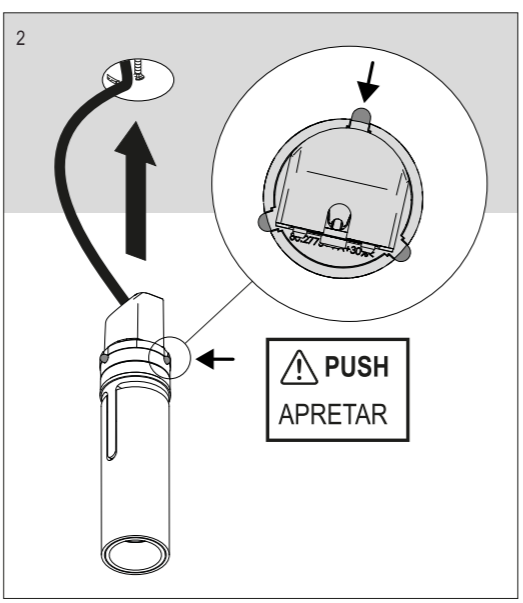

PUSH APRETAR

FIND ME Ø ref. 09.3781 / 09.3780

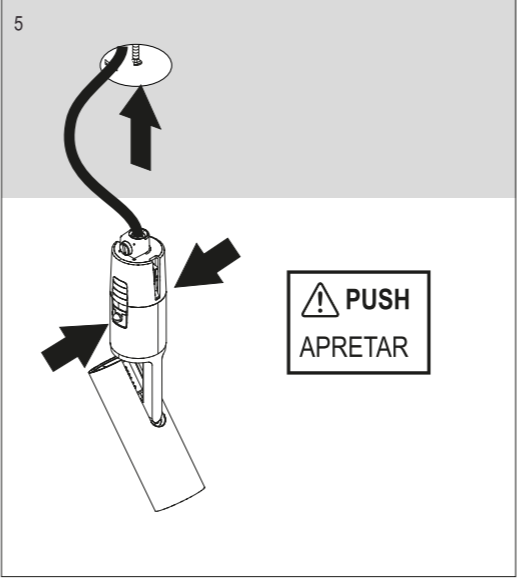
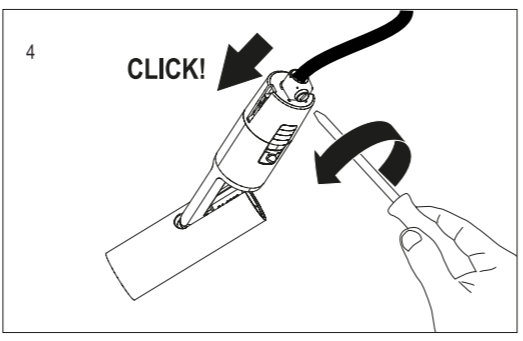
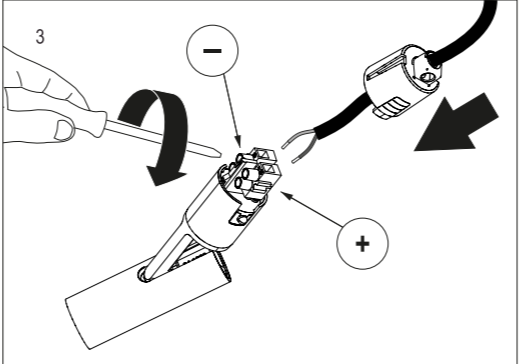
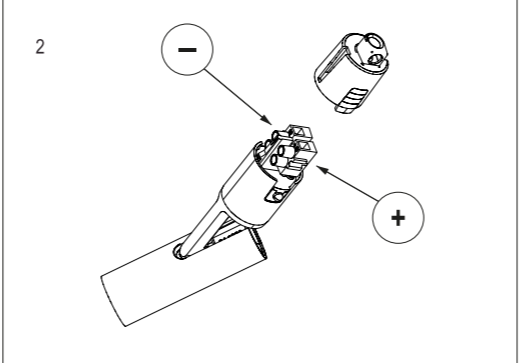
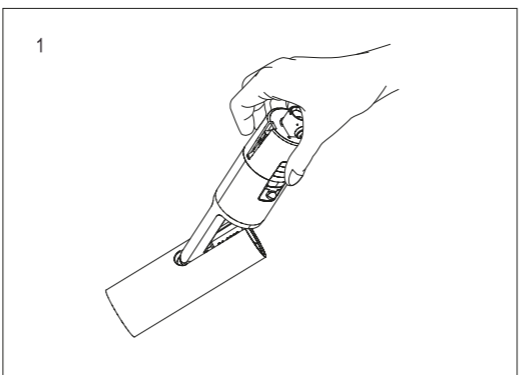

PUSH APRETAR

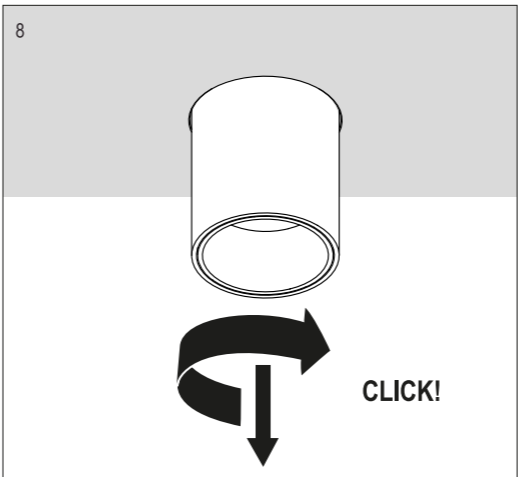
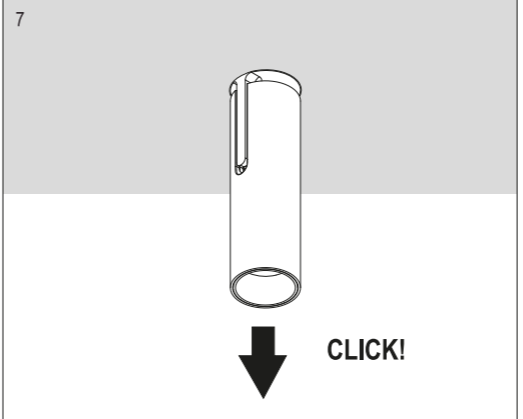
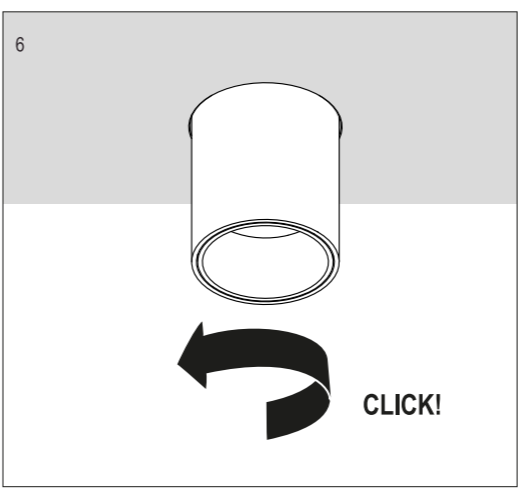

D LUMINAIRE TILT ADJUSTMENT

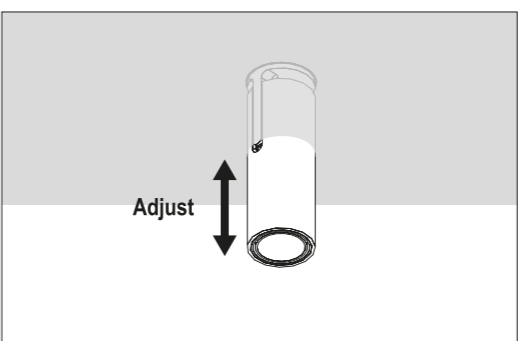
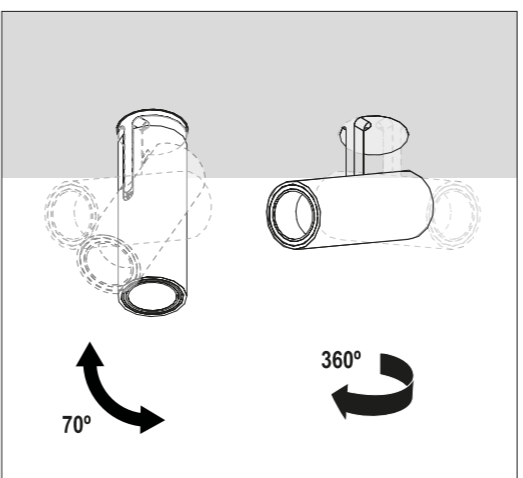

E ACCESSORIES

ACCESORIOS / ACCESSORI / ZUBEHÖR / ACCESSOIRES / ACCESSÓRIOS / アクセサリー / 配件 / AKCECCYAPI / KEPEK-ЖАРАДЫТАР / التجهيزات

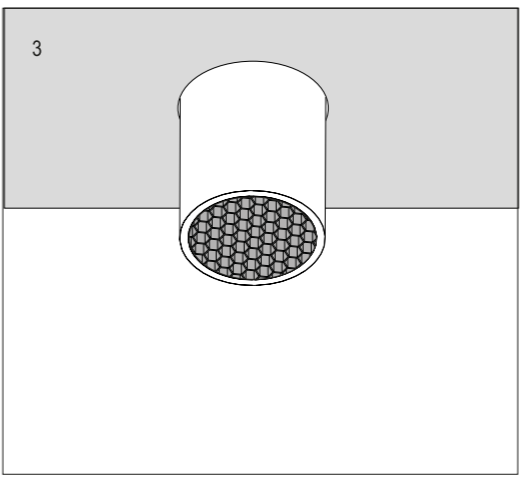
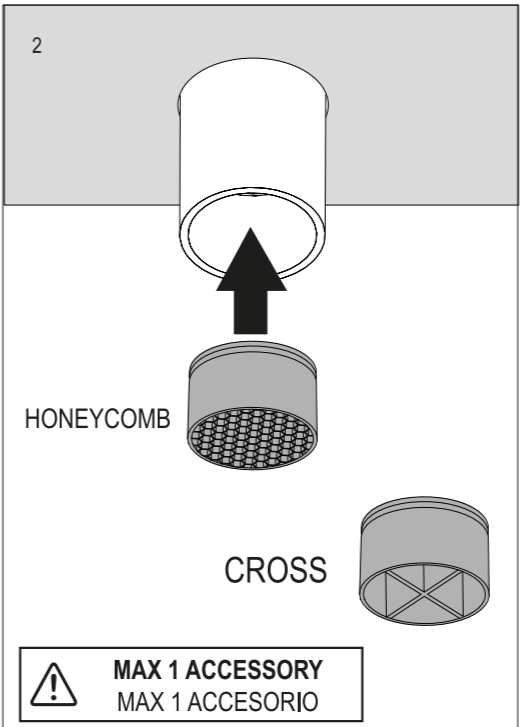
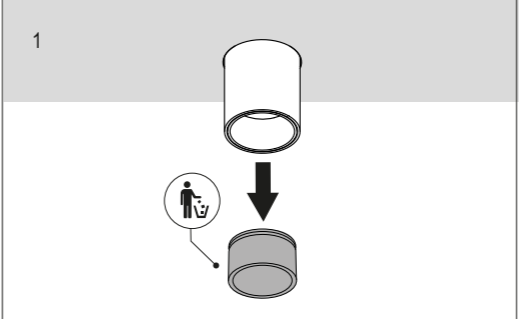

MAX 1 ACCESSORY MAX 1 ACCESORIO

FIND ME Ø ref. 09.3781 / 09.3780

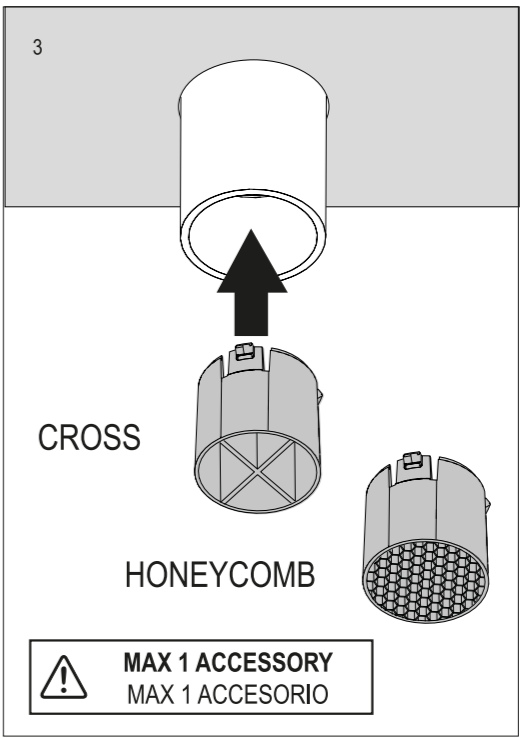
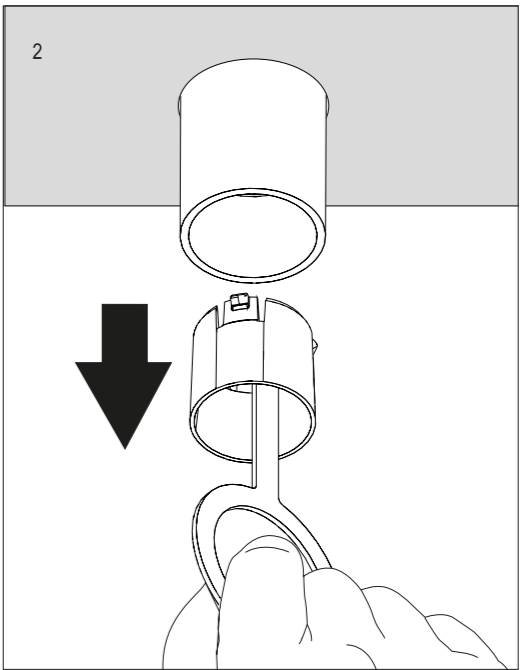
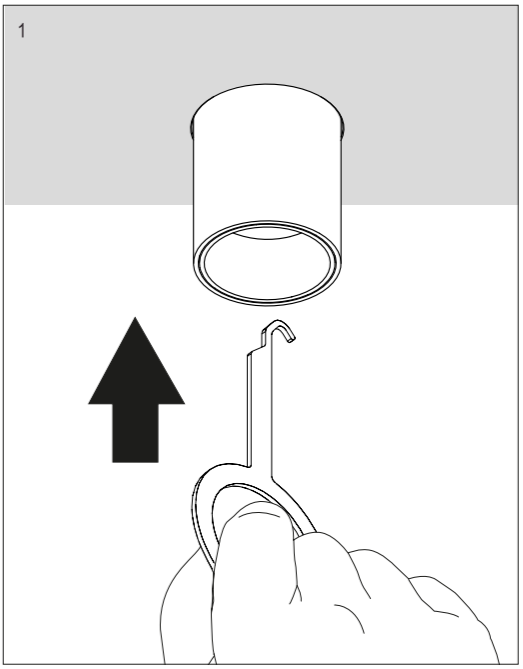

MAX 1 ACCESSORY MAX 1 ACCESORIO

WARNING! / ATENCIÓN!

E La luminaria debería colocarse de forma que no se espera una mirada prolongada a la luminaria a una distancia más cercana a X m

US The luminaire should be positioned so that prolonged staring into the luminaire at a distance of X m, is not expected.

GB The luminaire should be positioned so that prolonged staring into the luminaire at a distance of X m, is not expected.

I L'apparecchio dovrà essere collocato in modo che non ci si aspetti uno sguardo prolungato verso l'apparecchio da una distanza di circa x m.

D Die Lampe ist so zu positionieren, dass ein direkter Blick vermieden wird. Dies geschieht durch eine Längspositionierung auf x Metern Distanz.

F Le luminaire doit être positionné de manière à ne pas attendre un regard prolongé vers le luminaire à une distance proche de x mètres.

P A luminária deverá ser posicionada de tal forma que uma pessoa a x metros de distancia não mantenha o olhar prolongado à mesma..

JP 本照明器具は、X mより近い距離から内部を長時間凝視することがない場所に設置してください。

CN 请勿将灯具放置于接近于离视线 X 公尺的距离。

RU Светильник должен располагаться таким образом, чтобы длительное смотрение на светильник находилось на расстоянии x м

AR متر X لتجنب انظر الى الإنارة لمدة طويلة، يجب وضع الإنارة على مسافة أقرب من

KZ Ұзақ қарау күтілместей а x м-ға ең жақын дейінгі қашықтықтағы жарық түсіріпші құрылғы орналастырған жан

Ref.	
09.3750	X = 1,59 M
09.3751	
09.3755	
09.3756	

DIMENSION CONVERSION TABLE

mm	inch	
	1	0,39
	8	3,14
	10	3,93
	30	11,81
	50	19,68
	62	24,40
	70	27,55
	100	39,37
	125	49,21
	137	53,93
	150	59,05
	159	62,59