

# DOCUS

21-09-2015

## 1.0 LED

**LED** 8W | 220-240VAC | 50-60Hz | COB 2-step | incl. PS | phase-cut dim

CE IP20 960°C 0,3m 36° P

|                   |         |
|-------------------|---------|
| white texture     | 146364W |
| aluminium brushed | 146364L |
| gold              | 146364G |
| copper            | 146364P |
| black texture     | 146364B |

### LIGHT COLOUR

|                        |   |
|------------------------|---|
| 2200K   >80CRI   315lm | 1 |
| 2700K   >80CRI   480lm | 2 |
| 3000K   >80CRI   480lm | 4 |

## 1.0 PAR16

PAR16 max. 35W | GU10 | 220-240VAC | 50-60Hz

CE IP20 960°C 0,9m

|                   |          |
|-------------------|----------|
| white texture     | 146320W0 |
| aluminium brushed | 146320L0 |
| gold              | 146320G0 |
| copper            | 146320P0 |
| black texture     | 146320B0 |

### OPTIONAL

for PAR16 lamps see our catalogue

### OPTIONAL

|                      |          |
|----------------------|----------|
| inner cover max. 10W |          |
| white texture        | 911021W1 |
| gold                 | 911021G1 |
| black texture        | 911021B1 |

### base plate dimensions

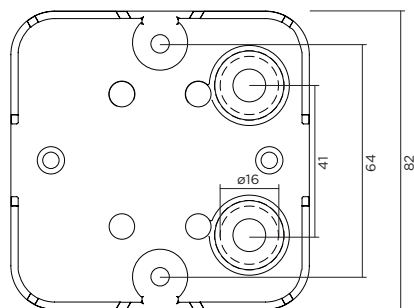

1.0 LED

1.0 PAR16

①

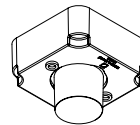
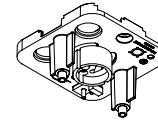
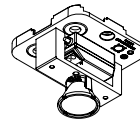

③

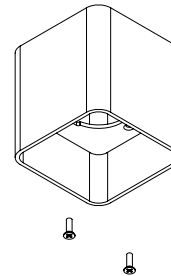
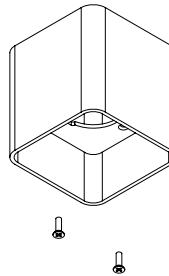

④

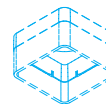
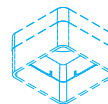

## DIMENSIONS



1.0 LED



1.0 PAR16

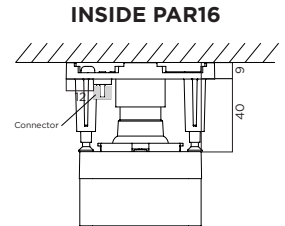

## ① MOUNTING INSTRUCTION

Remove the screws for the top part, put the cables through the opening and mount the base on the ceiling.

## ② POWER CONNECTION

SERIAL CONNECTION - for LED

**Always use POWER SUPPLY  
350mA / 500mA**

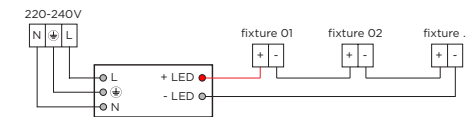

PARALLEL CONNECTION - for PAR16

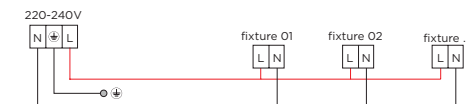

③ For LED:  
fix the plastic part together with the cover on the base with the screws.

For PAR16:  
fix the cover on the base with the screws.

④ OPTIONAL inner cover:  
put the inner cover in the outer cover and turn partially.  
In case of PAR16 with inner cover: max. 10W



WEVER & DUCRÉ  
LIGHTING

www.weverducre.com

INSTALLATION  
INSTRUCTIONS